

Quantum Computation

Ahto Buldas Aleksandr Lenin

Dec 2, 2019

Finding the Period of a Function



Peter Shor showed in 1994 that by using a quantum computer, it is possible to efficiently (in time $O(m^2)$) find the *period* of a wide class of functions $f: \mathbb{Z} \rightarrow \mathbb{Z}_{2^m}$.

The period of f is the least positive integer λ such that $f(x + \lambda) = f(x)$ for every argument x .

Shor's algorithm was one of the first quantum algorithms with serious practical consequences:

Efficient breakage of RSA and Elliptic curve cryptosystems with quantum computers

Searching from Unsorted Databases



Lov Grover showed in 1996 that quantum computers are able to:

- Search data from N -element unsorted databases in time $O(\sqrt{N})$.
- Find collisions for N -output hash functions in time $O(\sqrt[3]{N})$

In classical computational model:

- Searching from N -element unsorted database takes $O(N)$ time ($O(\log N)$ for sorted data).
- Finding collisions for N -output hash functions takes $O(\sqrt{N})$ time.

Factoring of $n = pq$ via Quantum Period Finding

The order $\text{ord}_n(a)$ of $a \in \mathbb{Z}_n^*$ is the period of $f(x) = a^x \pmod n$

- 1 Random element $a \leftarrow \mathbb{Z}_n^*$ is picked.
- 2 The period r of $f(x) = a^x \pmod n$ is found with success probability $\frac{1}{\ln n}$ using quantum computer.
- 3 Using a and r , a non-trivial $\sqrt{1}$ is found with probability $\frac{1}{2}$.
- 4 The modulus n is factored via $\sqrt{1}$.

This cycle is repeated until success.

Finding Non-Trivial $\sqrt{1}$ via $\text{ord}_n(\cdot)$

Lemma 1: If $p > 2$ is prime, $p - 1 = 2^d \cdot p'$, where p' is odd, the 2^d divides the order of exactly half of the elements of \mathbb{Z}_p^* .

Proof: Let g be a generator of \mathbb{Z}_p^* , $a = g^k \in \mathbb{Z}_p^*$, and $r = \text{ord}_p(a)$.

If k is odd, then $g^{kr} = 1$ and $\text{ord}_p(g) = p - 1 = |\mathbb{Z}_p^*|$ imply $p - 1 \mid kr$ and hence $2^d \mid r$.

If k is even, then $(g^k)^{\frac{p-1}{2}} = (g^{p-1})^{k/2} = 1^{k/2} = 1$ implies $r \mid \frac{p-1}{2}$ and hence $2^d \nmid r$. □

Lemma 2: If $n = pq$, where $p > q > 2$ are prime, then $r = \text{ord}_n(a)$ are even and $a^{\frac{r}{2}} \not\equiv -1 \pmod{n}$ for at least half of the elements $a \in \mathbb{Z}_n^*$.

Proof: It follows from CRT that $\mathbb{Z}_n^* \cong \mathbb{Z}_p^* \times \mathbb{Z}_q^*$ and picking $a \leftarrow \mathbb{Z}_n^*$ is equivalent to picking a random vector $(a_p, a_q) \in \mathbb{Z}_p^* \times \mathbb{Z}_q^*$, where $a_p \leftarrow \mathbb{Z}_p^*$ and $a_q \leftarrow \mathbb{Z}_q^*$ are independent random variables.

If $a \sim (a_p, a_q)$, then by $\text{ord}_n(a) = \text{lcm}(\text{ord}_p(a_p), \text{ord}_q(a_q))$ we have that $\text{ord}_n(a)$ can be odd only if $\text{ord}_p(a_p)$ and $\text{ord}_q(a_q)$ are both odd, the probability of which does not exceed $\frac{1}{4}$.

If $\text{ord}_n(a)$ is even and $a^{\frac{r}{2}} \equiv -1 \pmod{n}$, then $(a_p)^{\frac{r}{2}} \equiv -1 \pmod{p}$ and $(a_q)^{\frac{r}{2}} \equiv -1 \pmod{q}$. Hence, $\text{ord}_p(a_p) \nmid \frac{r}{2}$, and as $\text{ord}_p(a_p) \mid r$, we have $2^d \mid \text{ord}_p(a_p)$ and, analogously, $2^d \mid \text{ord}_q(a_q)$, that by Lemma 1, happens with probability $\frac{1}{4}$. □

$\Rightarrow \text{P}[a \leftarrow \mathbb{Z}_n^* : \text{ord}_n(a) \text{ is even and } a^{\frac{\text{ord}_n(a)}{2}} \text{ is non-trivial } \sqrt{-1}] \geq \frac{1}{2}$

Quantum Mechanics and Quantum Computers



1900: Planck claimed that electromagnetic energy could only be be a multiple of an elementary unit
 $E = h\nu$



~1920: Schrödinger, Bohr, Heisenberg, et al. developed the foundations of quantum mechanics



~1930: Dirac, von Neumann and Hilbert created modern quantum mechanics



1980-1985: Manin, Benioff, Feynman, and Deutsch created the foundations of quantum computation

State Space

The state space of a closed physical system (electron, whole universe, etc.) is a complex vector space V with inner product $\langle \cdot, \cdot \rangle$, so called *Hilbert space*.

State of a physical system is represented by a *unit vector* $\Psi \in V$, i.e.

$$\|\Psi\| = \sqrt{\langle \Psi, \Psi \rangle} = 1.$$

All information about the system is in Ψ .

Dynamics

If $\Psi(t)$ is the state at t and $\Psi(t')$ is the state at later time t' , then

$$\Psi(t') = U_{t,t'} \Psi(t) ,$$

where U is a *unitary* linear operator, i.e. $UU^\dagger = 1$, where U^\dagger is the *Hermitian conjugate*: a unique operator U , so that for every $\Psi, \Psi' \in V$:

$$\langle U\Psi, \Psi' \rangle = \langle \Psi, U^\dagger \Psi' \rangle$$

Operator U depends on the described system.

$U_{t,t'}$ is the solution of a differential equation $i\hbar \frac{\partial}{\partial t} \Psi = \mathcal{H}\Psi$, the *Schrödinger's equation*, integral from t to t' .

\mathcal{H} is the *Hamiltonian* operator that describes the energy of the system, $\hbar = \frac{h}{2\pi}$ is the reduced Planck constant and i is the imaginary unit.

Measurement

Measurement of a physical quantity is described by a mutually orthogonal set $\{V_i\}$ of subspaces that generate the whole space V .

V_i are V_j orthogonal: $\langle \Psi_i, \Psi_j \rangle = 0$ for every $\Psi_i \in V_i$ ja $\Psi_j \in V_j$

Every subspace V_i is associated with possible measurement result r_i

If $P_i: V \rightarrow V_i$ is the projection operator of the corresponding result, then after measurement, with probability $p_i = \|P_i\Psi\|^2$ the result is r_i and the state Ψ changes to

$$\Psi' = \frac{1}{\|P_i\Psi\|} P_i\Psi .$$

Quantum Bit (*qubit*)

Two-dimensional complex vector space V with basis vectors $|0\rangle$ ja $|1\rangle$

A qubit can be in a state:

$$\Psi = \alpha|0\rangle + \beta|1\rangle ,$$

where $\alpha, \beta \in \mathbb{C}$ ja $|\alpha|^2 + |\beta|^2 = 1$.

$|0\rangle$ and $|1\rangle$ are orthogonal.

The corresponding measurement results are 0 and 1.

Measurement of Ψ gives:

- $|0\rangle$ with probability $|\alpha|^2$
- $|1\rangle$ with probability $|\beta|^2$.

For example, measuring $\Psi = \frac{1}{\sqrt{2}}(|0\rangle + |1\rangle)$ gives 0 with probability $\frac{1}{2}$

Composition of Systems

Two *classical systems* with state sets S_1 and S_2 compose to a system with state set $S_1 \times S_2$ – *direct product*, the set of all ordered pairs (s_1, s_2) of states $s_1 \in S_1$ and $s_2 \in S_2$.

Two *quantum systems* with state spaces V_1 and V_2 compose to a system with state space $V_1 \otimes V_2$ (*tensor product*).

Let $\mathcal{L}(S)$ denote the complex vector space with basis S .

If $V_1 = \mathcal{L}(S_1)$ and $V_2 = \mathcal{L}(S_2)$, then

$$V_1 \otimes V_2 = \mathcal{L}(S_1 \times S_2) ,$$

i.e. tensor product is the complex vector space whose basis vectors are all possible ordered pairs (s_1, s_2) of basis vectors $s_1 \in S_1$ and $s_2 \in S_2$.

Two-Bit Quantum Register

The state space is the four-dimensional space $V \otimes V$, where V is the state space of a qubit with basis vectors $|0\rangle$ and $|1\rangle$.

The basis vectors are $|00\rangle$, $|01\rangle$, $|10\rangle$, and $|11\rangle$.

Two-bit quantum register can be in the state:

$$\Psi = \alpha|00\rangle + \beta|01\rangle + \gamma|10\rangle + \delta|11\rangle ,$$

where $\alpha, \beta, \gamma, \delta \in \mathbb{C}$ and $|\alpha|^2 + |\beta|^2 + |\gamma|^2 + |\delta|^2 = 1$.

n -Bit Quantum Register

The state space is 2^n -dimensional space $\underbrace{V \otimes V \otimes \dots \otimes V}_n$

The basis vectors are $|0..00\rangle, |0..01\rangle \dots |1..11\rangle$.

Exponential growth of the dimension is the main reason why the behavior of quantum mechanical systems is hard to model with classical computers.

Entanglement

Vectors of $V \otimes V$ that are not representable in the form

$$\begin{aligned}\Psi &= (a|0\rangle + b|1\rangle) \otimes (c|0\rangle + d|1\rangle) \\ &= ac|00\rangle + ad|01\rangle + bc|10\rangle + bd|11\rangle\end{aligned}$$

where $|a|^2 + |b|^2 = |c|^2 + |d|^2 = 1$ are called *entangled states*.

Homework exercise: Show that the following state is entangled:

$$\Psi = \frac{1}{\sqrt{2}}(|00\rangle + |11\rangle)$$

Einstein Podolsky Rosen (EPR) Paradox

Let XY be a two-bit quantum register that is in the state $\frac{1}{\sqrt{2}}(|00\rangle + |11\rangle)$

Alice takes the bit Y to Andromeda galaxy, X stays in Earth with Bob.



$X \leftarrow \dots \leftarrow XY \rightarrow \dots \rightarrow Y$



If Alice measures Y , then with probability $\frac{1}{2}$ she has 0 or 1.

With probability $\frac{1}{2}$ the state of the register immediately changes to $|00\rangle$ or to $|11\rangle$ and hence, *also X is now fixed*.

EPR paradox: How can X know immediately (faster than light) that Y has been measured?

Partial Measurement of a Quantum Register

If a part (e.g. Y) of a quantum register is measured, this cannot have any influence on the probability distributions of other parts (e.g. X).

Though Alice knows, what Bob gets when he measures X , but Bob does not know and for him, X is still random.

We say that X is in *mixed state*), that is a probabilistic combination of state vectors (*pure states*).

Principle of deferred measurement: all measurements during quantum computations can be postponed to the end of computations.

Principle of indirect measurement: if a qubit is not measured till the end of computation, then we can measure it right after creation.

Quantum Logic Gates

Quantum computations can be represented as a sequence of *quantum logic gates*.

m -bit quantum gate is a device that transforms input qubits x_0, \dots, x_{m-1} to output qubits y_0, \dots, y_{m-1} .

The action of quantum gates is unitary and can be represented by *unitary matrices*.

A single-bit quantum gate is represented by a unitary transform U with matrix $\begin{bmatrix} u_{00} & u_{01} \\ u_{10} & u_{11} \end{bmatrix}$ that converts the input qubit $\alpha|0\rangle + \beta|1\rangle$ to output qubit $\alpha'|0\rangle + \beta'|1\rangle$ so that:

$$\begin{bmatrix} \alpha' \\ \beta' \end{bmatrix} = \begin{bmatrix} u_{00} & u_{01} \\ u_{10} & u_{11} \end{bmatrix} \cdot \begin{bmatrix} \alpha \\ \beta \end{bmatrix} = \begin{bmatrix} u_{00}\alpha + u_{01}\beta \\ u_{10}\alpha + u_{11}\beta \end{bmatrix}$$

Quantum NOT-gate

NOT-gate is defined by the operations on base vectors as follows:

$$\text{NOT}(|0\rangle) = |1\rangle$$

$$\text{NOT}(|1\rangle) = |0\rangle$$

NOT-gate mixes the coefficients α and β of $\alpha|0\rangle + \beta|1\rangle$:

$$\text{NOT}(\alpha|0\rangle + \beta|1\rangle) = \beta|0\rangle + \alpha|1\rangle ,$$

NOT-gate is represented by the matrix $\begin{bmatrix} 0 & 1 \\ 1 & 0 \end{bmatrix}$.

$\text{NOT}(\text{NOT}(\Psi)) = \Psi$ for every state vector Ψ , because

$$\begin{bmatrix} 0 & 1 \\ 1 & 0 \end{bmatrix} \cdot \begin{bmatrix} 0 & 1 \\ 1 & 0 \end{bmatrix} = \begin{bmatrix} 1 & 0 \\ 0 & 1 \end{bmatrix} = I .$$

Hadamard Gate

Hadamard gate is defined by the operations on base vectors as follows:

$$\text{NOT}(|0\rangle) = \frac{|0\rangle + |1\rangle}{\sqrt{2}}$$

$$\text{NOT}(|1\rangle) = \frac{|0\rangle - |1\rangle}{\sqrt{2}}$$

Hadamard gate is represented by the matrix $H = \frac{1}{\sqrt{2}} \begin{bmatrix} 1 & 1 \\ 1 & -1 \end{bmatrix}$.

Homework exercise: Show that $HH = I$.

Phase Shift Gate

Phase shift gate is defined by the operations on base vectors as follows:

$$\begin{aligned}\text{NOT}(|0\rangle) &= |0\rangle \\ \text{NOT}(|1\rangle) &= e^{i\phi}|1\rangle\end{aligned}$$

Phase shift gate is represented by the matrix $R_\phi = \begin{bmatrix} 1 & 0 \\ 0 & e^{i\phi} \end{bmatrix}$.

Homework exercise: Show that $R_\phi R_{-\phi} = I$.

Controlled Inversion or Quantum XOR-Gate

Defined by the operations on base vectors as follows:

$$\begin{aligned} |00\rangle &\mapsto |00\rangle & |10\rangle &\mapsto |11\rangle \\ |01\rangle &\mapsto |01\rangle & |11\rangle &\mapsto |10\rangle \end{aligned}$$

i.e., second bit is inverted if the first bit is set. Denoted by:

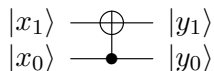

Controlled inversion gate is represented by the matrix:

$$\begin{bmatrix} 1 & 0 & 0 & 0 \\ 0 & 1 & 0 & 0 \\ 0 & 0 & 0 & 1 \\ 0 & 0 & 1 & 0 \end{bmatrix}$$

Swap Gate

Defined by the operations on base vectors as follows:

$$\begin{array}{ll} |00\rangle \mapsto |00\rangle & |10\rangle \mapsto |01\rangle \\ |01\rangle \mapsto |10\rangle & |11\rangle \mapsto |11\rangle \end{array}$$

i.e., the order of the bits is inverted.

Represented by the matrix:

$$\begin{bmatrix} 1 & 0 & 0 & 0 \\ 0 & 0 & 1 & 0 \\ 0 & 1 & 0 & 0 \\ 0 & 0 & 0 & 1 \end{bmatrix}$$

Controlled Phase Shift

Defined by the operations on base vectors as follows:

$$\begin{aligned} |00\rangle &\mapsto |00\rangle & |10\rangle &\mapsto |10\rangle \\ |01\rangle &\mapsto |01\rangle & |11\rangle &\mapsto e^{i\phi}|11\rangle \end{aligned}$$

i.e., if the first bit is set, the phase of second qubit is shifted. Denoted by:

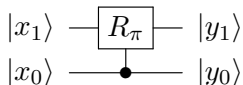

Represented by the matrix:

$$\begin{bmatrix} 1 & 0 & 0 & 0 \\ 0 & 1 & 0 & 0 \\ 0 & 0 & 1 & 0 \\ 0 & 0 & 0 & e^{i\phi} \end{bmatrix}$$

Example 1

Quantum circuit

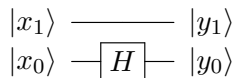

is represented by the matrix:

$$H \otimes I = \frac{1}{\sqrt{2}} \begin{bmatrix} 1 & 0 & 1 & 0 \\ 0 & 1 & 0 & 1 \\ 1 & 0 & -1 & 0 \\ 0 & 1 & 0 & -1 \end{bmatrix}$$

Example 2

Quantum circuit

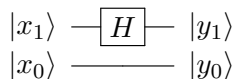

is represented by the matrix:

$$I \otimes H = \frac{1}{\sqrt{2}} \begin{bmatrix} 1 & 1 & 0 & 0 \\ 1 & -1 & 0 & 0 \\ 0 & 0 & 1 & 1 \\ 0 & 0 & 1 & -1 \end{bmatrix}$$

Example 3

Quantum circuit

$$\begin{array}{c} |x_1\rangle \text{ --- } \boxed{H} \text{ --- } |y_1\rangle \\ |x_0\rangle \text{ --- } \boxed{H} \text{ --- } |y_0\rangle \end{array}$$

is represented by the matrix:

$$H \otimes H = \frac{1}{2} \begin{bmatrix} 1 & 1 & 1 & 1 \\ 1 & -1 & 1 & -1 \\ 1 & 1 & -1 & -1 \\ 1 & -1 & -1 & 1 \end{bmatrix}$$

For example:

$$\begin{aligned} (H \otimes H)|00\rangle &= H|0\rangle \otimes H|0\rangle = \frac{1}{\sqrt{2}}(|0\rangle + |1\rangle) \otimes \frac{1}{\sqrt{2}}(|0\rangle + |1\rangle) \\ &= \frac{1}{2}(|00\rangle + |01\rangle + |10\rangle + |11\rangle) \end{aligned}$$

Example 4

Quantum circuit

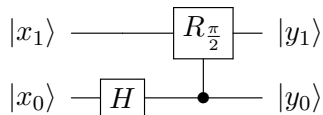

is represented by the matrix:

$$\begin{bmatrix} 1 & 0 & 0 & 0 \\ 0 & 1 & 0 & 0 \\ 0 & 0 & 1 & 0 \\ 0 & 0 & 0 & i \end{bmatrix} \cdot \begin{bmatrix} 1 & 0 & 1 & 0 \\ 0 & 1 & 0 & 1 \\ 1 & 0 & -1 & 0 \\ 0 & 1 & 0 & -1 \end{bmatrix} = \begin{bmatrix} 1 & 0 & 1 & 0 \\ 0 & 1 & 0 & 1 \\ 1 & 0 & -1 & 0 \\ 0 & i & 0 & -i \end{bmatrix}$$

Non-Cloning Theorem

Cloner is a unitary operator with a state Φ , such that for every state Ψ we have $U: |\Psi\rangle|\Phi\rangle \mapsto |\Psi\rangle|\Psi\rangle$.

Say, $|\Phi\rangle = |0\rangle$. In this case, $U: |0\rangle|0\rangle \mapsto |0\rangle|0\rangle$ and $U: |1\rangle|0\rangle \mapsto |1\rangle|1\rangle$.
By the linearity of U :

$$U: \left(\frac{1}{\sqrt{2}}|0\rangle + \frac{1}{\sqrt{2}}|1\rangle \right) |0\rangle \mapsto \frac{1}{\sqrt{2}}|0\rangle|0\rangle + \frac{1}{\sqrt{2}}|1\rangle|1\rangle$$

On the other hand,

$$\left(\frac{1}{\sqrt{2}}|0\rangle + \frac{1}{\sqrt{2}}|1\rangle \right) \left(\frac{1}{\sqrt{2}}|0\rangle + \frac{1}{\sqrt{2}}|1\rangle \right) \neq \frac{1}{\sqrt{2}}|0\rangle|0\rangle + \frac{1}{\sqrt{2}}|1\rangle|1\rangle$$

Simulating Classical Circuits

For every classical logic circuit (say, with AND- and NOT gates) that computes a function $f: \{0, 1\}^n \rightarrow \{0, 1\}^m$, there is a quantum circuit U that transforms a $(n + m)$ -qubit quantum register in the following way:

$$U: |x\rangle|y\rangle \mapsto |x\rangle|y \oplus f(x)\rangle ,$$

which means that $|x\rangle|0^m\rangle \mapsto |x\rangle|f(x)\rangle$.

Quantum Parrallelism

Hadamard gate $H^{\otimes n}$ converts $|0^n\rangle|0^m\rangle$ to the superposition

$$\frac{1}{\sqrt{N}} \sum_{x=0}^{N-1} |x\rangle|0^m\rangle ,$$

where $N = 2^n$. By applying U , we get a superposition

$$\frac{1}{\sqrt{N}} \sum_{x=0}^{N-1} |x\rangle|f(x)\rangle$$

Analogous to classical parallel computation with 2^n *threads*, but threads are not separately accessible (no measurement!)

By measuring the output, one single value $y = f(x)$ is obtained. This is the same as classical computation where $x \leftarrow \{0, 1\}^n$ and $y \leftarrow f(x)$.

Exchanging Information Between Threads

In classical computation, threads can exchange information in arbitrary way.

In quantum computation, such information exchange is limited.

For example, if all threads compute a one-bit output, there are no known ways how compute the product of those bits.

If this is possible, one can solve the so-called **NP**-complete combinatorial problems efficiently with quantum computer.

This is widely belived (among complexity theoreticians) to be impossible.

Quantum Fourier Transform (QFT)

Classical Fourier Transform (FT) converts a vector $(x_0, \dots, x_{N-1}) \in \mathbb{C}^N$ to vector $(y_0, \dots, y_{N-1}) \in \mathbb{C}^N$ so that:

$$y_k = \frac{1}{\sqrt{N}} \sum_{j=0}^{N-1} x_j e^{2\pi i \frac{jk}{N}} . \quad (1)$$

QFT converts $\sum_{i=0}^{N-1} x_i |i\rangle$ to state $\sum_{i=0}^{N-1} y_i |i\rangle$ using (1).

If $N = 2$, then $x_0|0\rangle + x_1|1\rangle$ maps to $\frac{x_0+x_1}{\sqrt{2}}|0\rangle + \frac{x_0-x_1}{\sqrt{2}}|1\rangle$. In matrix form:

$$\begin{bmatrix} y_0 \\ y_1 \end{bmatrix} = \frac{1}{\sqrt{2}} \begin{bmatrix} 1 & 1 \\ 1 & -1 \end{bmatrix} \cdot \begin{bmatrix} x_0 \\ x_1 \end{bmatrix} = H \cdot \begin{bmatrix} x_0 \\ x_1 \end{bmatrix} .$$

Using the notation $\omega = e^{\frac{2\pi i}{N}}$, for $N = 4$ the QFT is represented by:

$$\frac{1}{2} \begin{bmatrix} 1 & 1 & 1 & 1 \\ 1 & \omega & \omega^2 & \omega^3 \\ 1 & \omega^2 & \omega^4 & \omega^6 \\ 1 & \omega^3 & \omega^6 & \omega^9 \end{bmatrix} = \frac{1}{2} \begin{bmatrix} 1 & 1 & 1 & 1 \\ 1 & i & -1 & -i \\ 1 & -1 & 1 & -1 \\ 1 & -i & -1 & i \end{bmatrix}$$

QFT₂ as a quantum circuit:

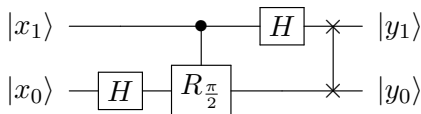

This corresponds to the next product of matrices:

$$\underbrace{\begin{bmatrix} 1 & 0 & 0 & 0 \\ 0 & 0 & 1 & 0 \\ 0 & 1 & 0 & 0 \\ 0 & 0 & 0 & 1 \end{bmatrix}}_{\text{swap}} \cdot \underbrace{\begin{bmatrix} 1 & 1 & 0 & 0 \\ 1 & -1 & 0 & 0 \\ 0 & 0 & 1 & 1 \\ 0 & 0 & 1 & -1 \end{bmatrix}}_{\text{second } H} \cdot \underbrace{\begin{bmatrix} 1 & 0 & 0 & 0 \\ 0 & 1 & 0 & 0 \\ 0 & 0 & 1 & 0 \\ 0 & 0 & 0 & i \end{bmatrix}}_{\text{phase shift}} \cdot \underbrace{\begin{bmatrix} 1 & 0 & 1 & 0 \\ 0 & 1 & 0 & 1 \\ 1 & 0 & -1 & 0 \\ 0 & 1 & 0 & -1 \end{bmatrix}}_{\text{first } H}$$

The next figure depicts a general recursive construction of QFT_n (if $N = 2^n$) using QFT_{n-1} . Schemes are presented without the last swap.

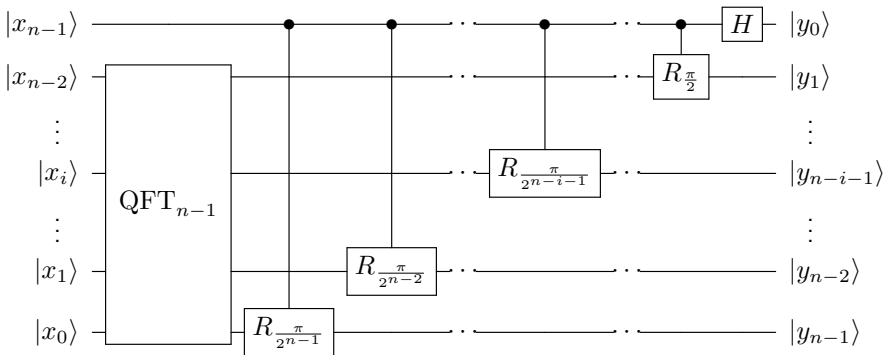

Period Finding with Shor's Algorithm

Let $F: |x, y\rangle \mapsto |x, y \oplus f(x)\rangle$ be a quantum circuit that computes an r -periodic function $f: \mathbb{Z} \rightarrow \mathbb{Z}_{2^m}$. Let $r < 2^{n-1}$ and $N = 2^{2n}$.

We use two quantum registers: $2n$ -qubit X and m -qubit Y .

Shor's algorithm (initially, XY is in the state $|0^{2n}, 0^m\rangle$)

S1 Using $H^{\oplus 2n}$ create the superposition $\Psi = \frac{1}{\sqrt{N}} \sum_{i=0}^{N-1} |i, 0\rangle$

S2 Using F compute the superposition $\Phi = \frac{1}{\sqrt{N}} \sum_{i=0}^{N-1} |i, f(i)\rangle$

S3 Measure the register Y (actually unnecessary!)

S4 Apply QFT_{2n} to X

S5 Measure X to obtain $|i_0\rangle$, where $i_0 \approx \lambda \frac{N}{r}$ ja $\lambda \in \mathbb{Z}_r$

$$|0^{2n}, 0^m\rangle \xrightarrow{H^{\oplus 2n}} \Psi \xrightarrow{F} \Phi \xrightarrow{\text{QFT}_{2n}} \Phi_0 \xrightarrow{\mathcal{M}} |i_0, *\rangle \text{ kus } i_0 \approx \lambda \frac{N}{r}$$

Step S3: After Measuring Y

The result is $|*, k\rangle$, where $k = f(s)$ and s is chosen so that $s < r$.

A f is r -periodic, we obtain a superposition Φ' of $|x_j, k\rangle$, where $x_j = s + jr$. There are $p = \lceil N/r \rceil$ of such states. Hence:

$$\Phi' = \frac{1}{\sqrt{p}} \sum_{j=0}^{p-1} |s + jr, k\rangle .$$

Actually, S3 *unnecessary* because of the *deferred measurement principle*.

Register Y can be transported to Andromeda galaxy and measuring Y cannot have any influence over later measurements of X .



$X \leftarrow \dots \leftarrow XY \rightarrow \dots \rightarrow Y$



What happens if we measure X now?

The result is $|s + jr, k\rangle$.

If f is one to one in \mathbb{Z}_r , then s is uniformly distributed.

Also j is uniformly distributed on \mathbb{Z}_p .

Hence, if $\frac{N}{r} \in \mathbb{Z}$, then $s + jr$ is uniformly distributed on \mathbb{Z}_N and does not contain any information about r .

If we repeat the experiment from S1, we get $|s' + j'r, k'\rangle$, where s' and j' are independent of s and j , and hence, $s' + j'r$ is independent of $s + jr$.

Therefore, repeating gives us nothing!

Step S4: QFT

“Filters out” the random shift s .

After applying QFT_{2n} we get:

$$\begin{aligned}\Phi_0 &= \text{QFT}_{2n} \Phi' = \frac{1}{\sqrt{pN}} \sum_{i=0}^{N-1} \left(\sum_{j=0}^{p-1} e^{2\pi i \frac{i(s+jr)}{N}} \right) |i, k\rangle \\ &= \frac{1}{\sqrt{pN}} \sum_{i=0}^{N-1} e^{2\pi i \frac{is}{N}} \left(\sum_{j=0}^{p-1} e^{2\pi i \frac{ijr}{N}} \right) |i, k\rangle\end{aligned}$$

$$|e^{2\pi i \frac{is}{N}}| = 1 \text{ and}$$

$$\left| \sum_{j=0}^{p-1} e^{2\pi i \frac{ijr}{N}} \right| \approx \begin{cases} p & \text{if } \frac{ir}{N} \in \mathbb{Z}, \text{ i.e. if } i \text{ is a multiple of } \frac{N}{r} \\ 0 & \text{if } \frac{ir}{N} \notin \mathbb{Z} \end{cases}$$

Explanation:

$$\lim_{p \rightarrow \infty} \frac{1}{p} \sum_{j=0}^{p-1} e^{2\pi i \alpha j} = \begin{cases} 1 & \text{if } \alpha \in \mathbb{Z} \\ 0 & \text{if } \alpha \notin \mathbb{Z} \end{cases} .$$

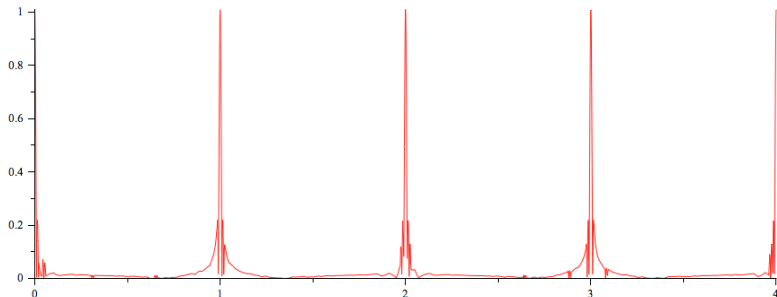

The graph of $g(\alpha) = \frac{1}{p} \sum_{j=0}^{p-1} e^{2\pi i \alpha j}$ if $p = 100$.

Step S5: Measuring X

We obtain $i \approx \lambda \frac{N}{r}$ kus $\lambda \in \mathbb{Z}_r$, i.e. $\left| \frac{i}{N} - \frac{\lambda}{r} \right| < 2^{-2n}$.

If $r, r' < 2^{n-1}$ ja $\frac{\lambda}{r} \neq \frac{\lambda'}{r'}$ then $\lambda r' \neq \lambda' r$ and thus

$$\left| \frac{\lambda}{r} - \frac{\lambda'}{r'} \right| = \frac{|\lambda r' - \lambda' r|}{rr'} \geq \frac{1}{rr'} \geq 4 \cdot 2^{-2n}$$

Hence, a rational approximation $\frac{a}{b}$ of $\frac{i}{N} = i \cdot 2^{-2n}$ with restriction $b < 2^{n-1}$ is uniquely defined.

The best rational approximation $\frac{a}{b}$ with $b < M$ can be found in time $O(\log M)$ by using *continued fractions*. If $M = 2^n$, then in time $O(n)$.

If $\gcd(\lambda, r) = 1$ then $b = r$. It is sufficient that λ is a *prime*.

This happens with probability about $\frac{1}{\ln r} = \frac{1}{O(n)}$ and hence $O(n)$ trials are sufficient to find r .

Continued Fractions

Denote

$$[a_0; a_1; \dots; a_n] = a_0 + \frac{1}{a_1 + \frac{1}{\dots + \frac{1}{a_n}}} = [a_0; a_1; \dots; a_n - 1; 1]$$

Every rational number $x \geq 1$ can be represented with continued fractions.
For example:

$$\begin{aligned} \frac{31}{13} &= 2 + \frac{5}{13} = 2 + \frac{1}{\frac{13}{5}} = 2 + \frac{1}{2 + \frac{3}{5}} = 2 + \frac{1}{2 + \frac{1}{\frac{5}{3}}} = 2 + \frac{1}{2 + \frac{1}{1 + \frac{2}{3}}} \\ &= 2 + \frac{1}{2 + \frac{1}{1 + \frac{1}{\frac{3}{2}}}} = 2 + \frac{1}{2 + \frac{1}{1 + \frac{1}{1 + \frac{1}{2}}}} = [2; 2; 1; 1; 2] \\ &= 2 + \frac{1}{2 + \frac{1}{1 + \frac{1}{1 + \frac{1}{1 + \frac{1}{1}}}}} = [2; 2; 1; 1; 1; 1] \end{aligned}$$

Theorem: $[a_0; a_1; \dots; a_n] = \frac{p_n}{q_n}$, where $p_0 = a_0$, $q_0 = 1$, $p_1 = 1 + a_0a_1$, $q_1 = a_1$,

$$p_n = a_n p_{n-1} + p_{n-2}$$

$$q_n = a_n q_{n-1} + q_{n-2}$$

Proof: Induction on n :

- *Basis:* $[a_0] = a_0 = \frac{a_0}{1} = \frac{p_0}{q_0}$ and $[a_0; a_1] = a_0 + \frac{1}{a_1} = \frac{1+a_0a_1}{a_1} = \frac{p_1}{q_1}$.
- *Step:* if the claim is true for $n - 1$ then:

$$\begin{aligned} [a_0; \dots; a_n] &= [a_0; a_1; \dots; a_{n-1} + \frac{1}{a_n}] = \frac{\tilde{p}_{n-1}}{\tilde{q}_{n-1}} \\ &= \frac{(a_{n-1} + \frac{1}{a_n})p_{n-2} + p_{n-3}}{(a_{n-1} + \frac{1}{a_n})q_{n-2} + q_{n-3}} = \frac{p_{n-1} + p_{n-2}/a_n}{q_{n-1} + q_{n-2}/a_n} = \frac{p_n}{q_n} \end{aligned}$$

because $\tilde{p}_{n-2} = p_{n-2}$, $\tilde{q}_{n-2} = q_{n-2}$, $\tilde{p}_{n-3} = p_{n-3}$, $\tilde{q}_{n-3} = q_{n-3}$. □

Corollary: $p_n \geq p_{n-1} \geq \dots \geq p_1 \geq p_0$ ja $q_n \geq q_{n-1} \geq \dots \geq q_1 \geq q_0$.

Lemma: $q_n p_{n-1} - p_n q_{n-1} = (-1)^n$ for every $n > 0$.

Proof: Induction on n :

- *Basis:* $r_1 = q_1 p_0 - p_1 q_0 = a_0 a_1 - (1 + a_0 a_1) \cdot 1 = -1 = (-1)^1$.
- *Step:* If $r_{n-1} = q_{n-1} p_{n-2} - p_{n-1} q_{n-2} = (-1)^{n-1}$ then:

$$\begin{aligned} r_n &= q_n p_{n-1} - p_n q_{n-1} \\ &= (a_n q_{n-1} + q_{n-2}) p_{n-1} - (a_n p_{n-1} + p_{n-2}) q_{n-1} \\ &= -(q_{n-1} p_{n-2} - p_{n-1} q_{n-2}) = -r_{n-1} = -(-1)^{n-1} = (-1)^n \end{aligned}$$

□

Theorem: Let $x \in \mathbb{Q}$ ja $\frac{p}{q} = [a_0; a_1; \dots; a_n] \in \mathbb{Q}$ (i.e. $\frac{p}{q} = \frac{p_n}{q_n}$) such that

$$\left| \frac{p}{q} - x \right| \leq \frac{1}{2q^2} . \quad (2)$$

Then there exist a_{n+1}, \dots, a_N , so that $x = [a_0; a_1; \dots; a_n; a_{n+1}; \dots; a_N]$, i.e. the continued fraction of $\frac{p}{q}$ is the continued fraction of x .

Proof: Define δ so that $x = \frac{p_n}{q_n} + \frac{\delta}{2q_n^2}$. Then by (2) we have $|\delta| < 1$. Let

$$\lambda = 2 \cdot \frac{q_n p_{n-1} - p_n q_{n-1}}{\delta} - \frac{q_{n-1}}{q_n} .$$

then ...

...

$$\begin{aligned} [a_0; \dots; a_n; \lambda] &= \frac{\lambda p_n + p_{n-1}}{\lambda q_n + q_{n-1}} \\ &= \frac{2p_n \frac{q_n p_{n-1} - p_n q_{n-1}}{\delta} - q_{n-1} \frac{p_n}{q_n} + p_{n-1}}{2q_n \cdot \frac{q_n p_{n-1} - p_n q_{n-1}}{\delta}} \\ &= \frac{p_n}{q_n} + \frac{\delta}{2q_n^2} = x \end{aligned}$$

We choose n to be even and get $\lambda = \frac{2}{\delta} - \frac{q_{n-1}}{q_n} > 2 - 1 = 1$ Hence, there are a_{n+1}, \dots, a_N such that $\lambda = [a_{n+1}; \dots; a_N]$ and

$$x = [a_0; \dots; a_n; \lambda] = [a_0; \dots; a_n; a_{n+1}; \dots; a_N]$$

